

ROFITT

ПОЛИЭТИЛЕНОВЫЕ ФИТИНГИ И ШАРОВЫЕ КРАНЫ

СОЕДИНЯЕТ



Все продукты
компании
соответствуют:

EN 12201 EN 1555



СЕРТИФИКАТЫ СДС ГАЗСЕРТ



СЕРТИФИКАТЫ РСТ И ЕАЭС



МЕЖДУНАРОДНЫЕ СЕРТИФИКАТЫ





ROFITT

Продукция ROFITT – это высококачественные фитинги и шаровые краны из полиэтилена PE100 (ПЭ100) и PE-RT (ПЭ-РТ) для трубопроводных систем водо- и газоснабжения, а также теплоснабжения.

Применяются в трубопроводах малого и среднего давления до 1.6 МПа для жидких сред и до 1.0 МПа для газообразных сред.

В производстве ПЭ продукции используется первичный полиэтилен марки HE3490-IM (HE3490-LS), производства компании Borouge, принадлежащей компаниям ADNOC (ОАЭ) и Borealis AG (Австрия).

Для производства PE-RT фитингов используется полиэтилен PE-RT тип II марок TOTAL XRT 70, HOSTALEN 4731b и DOWLEX 2388.

Фитинги и краны ROFITT отвечают требованиям европейских стандартов качества EN1555-4, EN12201-3, ISO 10933, CE, имеют сертификацию ГОСТ-Р, Свидетельство о государственной регистрации, а также Заключение экспертизы промышленной безопасности для использования на опасных производственных объектах сетей газораспределения и газопотребления.

В 2018 году ПЭ фитинги и краны ROFITT прошли успешные испытания и были сертифицированы в СДС ГАЗСЕРТ на соответствие требованиям ГОСТ к сетям газораспределения.

Широкий ассортимент и размерный ряд электросварных фитингов (от 20 мм. до 630 мм.), литых фитингов (от 20 мм. до 1200 мм.) и полнопроходных шаровых кранов (от 32 мм. до 315 мм.) позволяет осуществлять максимально полную комплектацию объектов.

Коррозионная стойкость, прочность и надежная конструкция фитингов и кранов ROFITT позволяют обеспечить долгосрочную безаварийную эксплуатацию трубопроводов.

Выбирая нашу продукцию, **Вы выбираете профессионального производителя** с многолетней историей и опытом в разработке и изготовлении полиэтиленовых фитингов и кранов, идущего по пути постоянного развития и инноваций!

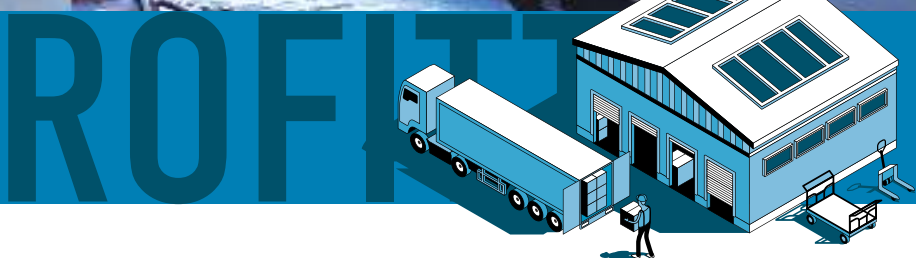

Производство

Продукция ROFITT производится с использованием самого современного оборудования и технологий в сфере литья пластмасс под давлением на крупном промышленном предприятии.

Производство функционирует с 1991 года. Общее количество занятых работников составляет порядка 400 человек, производственная площадь 100 000 м². На начало 2018 года парк термопластавтоматов насчитывает более 60 машин – как небольших скоростных ТПА, так и с усилием смыкания до 2100 тонн.

С 2015 года введены в эксплуатацию 6 автоматических роботизированных линий для производства электросварных муфт. Японские роботы производства Fanuc, Yaskawa Motoman и Nachi обеспечивают высокопроизводительную работу автоматических линий с минимальным участием оператора 24 часа в сутки.

Лаборатория завода также оснащена новейшим современным оборудованием, имеет международную аккредитацию. Осуществляется строгий входной контроль материалов, а также контроль качества готовой продукции.

Общая производимая номенклатура насчитывает более 2000 единиц продукции, диаметры производимых фитингов от 20 до 1200 мм.

Главный партнер – крупнейший мировой производитель литьевого полимерного оборудования, компания **HAITIAN International**, обеспечивает безупречное качество, скорость и экономичность производственного процесса.

Вместе с использованием высококлассного сырья признанных мировых лидеров в производстве полимерного сырья компаний **Borouge** (ОАЭ) и **Borealis** (Австрия), осуществляется тщательный контроль качества на всех стадиях производства, **что гарантирует надежность** каждого выпущенного изделия.



ПОЛИЭТИЛЕНОВЫЙ ШАРОВОЙ КРАН ПОЛНОПРОХОДНОЙ SDR 11

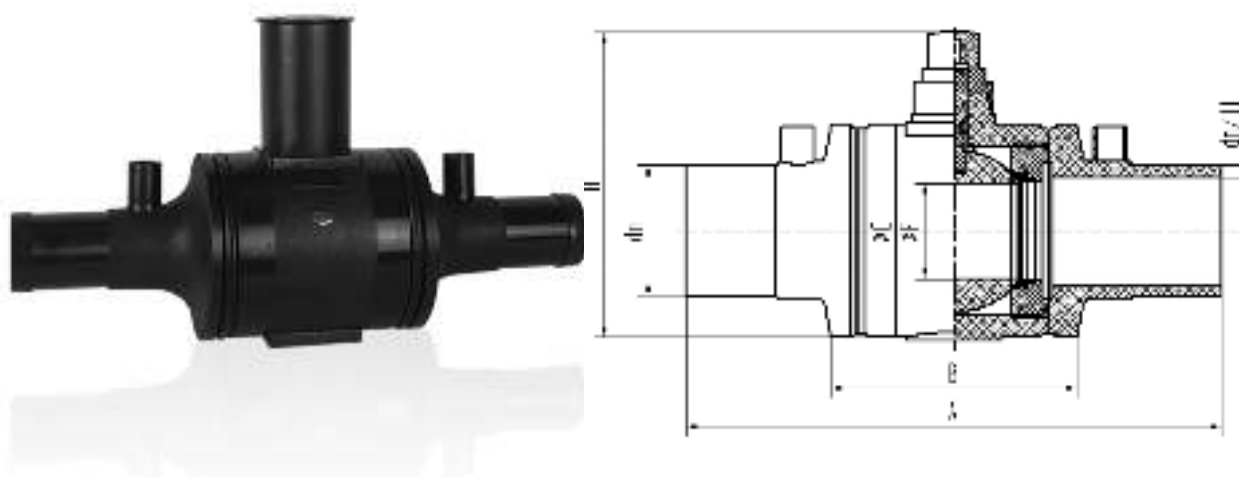

Артикул	dn	A	B	Ø C	Ø E	H	Вес, кг
VS32	32	540	178	125	46	250	1,5
VS50	50	540	178	125	46	250	2,2
VS63	63	540	178	125	46	250	2,3
VS90	90	700	290	225	89	380	9,5
VS110	110	700	290	225	89	380	12
VS125	125	700	290	225	89	380	14
VS160	160	860	345	318	150	470	26
VS200	200	860	345	318	150	470	48
VS225	225	1015	465	405	182	550	60
VS250	250	1015	465	405	182	550	64
VS315	315	1050	488	464	221	640	74

Полиэтиленовые шаровые краны ROFITT применяются в наружных системах напорных трубопроводов газоснабжения, водоснабжения и водоотведения диаметрами от 32 мм до 315 мм. Также шаровые краны ROFITT используются при строительстве сетей в промышленности, транспортирующих химические вещества, к которым стоек полиэтилен.

Шаровые краны торговой марки ROFITT производятся из ПЭ 100 марки 3490 IM (LS), предназначены для соединения с трубами из полиэтилена марок ПЭ 80, ПЭ 100, и рассчитаны на рабочее давление: газ - от 20 мбар до 10 бар, вода до 16 бар. Класс герметичности - А.

Краны производятся в соответствии с ТР ТС 010/2011 «О безопасности машин и оборудования» и соответствуют требованиям ГОСТ Р 53672-2009 Арматура трубопроводная, также соответствуют требованиям ГОСТ Р 55472-2013 Системы газораспределительные. Шаровые краны ROFITT сертифицированы СДС ГАЗСЕРТ.

По запросу заказчиков, шаровые краны комплектуются телескопическими штоками длиной от 1,0 до 2,5 метров, а также плитой, ковером, ключами и другим доп. оборудованием.



МУФТА СОЕДИНИТЕЛЬНАЯ ЭЛЕКТРОСВАРНАЯ SDR 11, SDR 17



Артикул	dn(mm)	Ø A	Ø B	L	H	SDR
EI20	20	30	4,7	90	35	11
EI25	25	35	4,7	78	35	11
EI32	32	42	4,7	90	40	11
EI40	40	52	4,7	92	44	11
EI50	50	64	4,7	110	50	11
EI63	63	80	4,7	123	58	11
EI75	75	95	4,7	140	68	11
EI90	90	112	4,7	146	75	11
EI110	110	134	4,7	160	90	11
EI125	125	154	4,7	180	97	11
EI160	160	196	4,7	184	106	11
EI180	180	220	4,7	200	140	11
EI200	200	242	4,7	195	138	11
EI225	225	272	4,7	227	153	11
EI250	250	302	4,7	232	172	11
EI280	280	338	4,7	240	196	11
EI315	315	374	4,7	235	209	11
EI355	355	426	4,7	282	213	11
EI400	400	454	4,7	355	241	11,17
EI450	450	510	4,7	385	273	11,17
EI500	500	566	4,7	405	302	11,17
EI560	560	634	4,7	455	328	17
EI630	630	713	4,7	505	380	17
EI710	710	803	4,7	356 ?	402 ?	17

Переход электросварной SDR 11

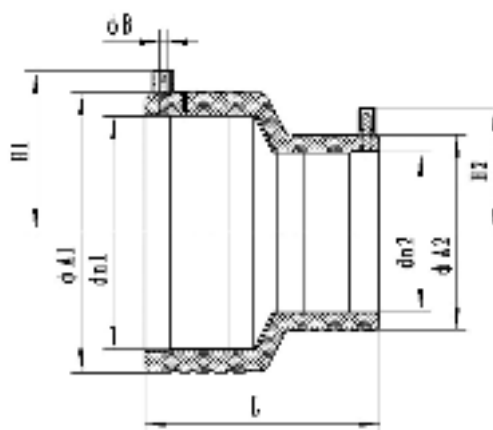

Артикул	dn1x dn2 (mm)	Ø A1	H1	A2	H2	Ø B	L
EY25x20	25x20	35	38	30	35	4,7	100
EY32x25	32x25	42	41	35	38	4,7	100
EY40x32	40x32	52	46	42	41	4,7	102
EY50x32	50x32	64	52	42	41	4,7	107
EY50x40	50x40	64	52	52	46	4,7	110
EY63x32	63x32	80	60	42	41	4,7	123
EY63x40	63x40	80	60	52	46	4,7	125
EY63x50	63x50	80	60	64	52	4,7	125
EY75x63	75x63	95	68	80	60	4,7	140
EY90x63	90x63	112	76	80	60	4,7	158
EY90x75	90x75	112	76	95	68	4,7	164
EY110x63	110x63	134	87	80	60	4,7	170
EY110x75	110x75	134	87	97	70	4,7	170
EY110x90	110x90	134	87	112	76	4,7	175
EY160x90	160x90	190	112	112	76	4,7	195
EY160x110	160x110	190	112	134	80	4,7	195
EY200x90	200x90	240	130	112	76	4,7	215
EY200x110	200x110	240	130	134	80	4,7	215
EY200x160	200x160	240	130	190	112	4,7	215
EY225x160	225x160	270	149	190	116	4,7	223
EY250x160	250x160	305	161	190	112	4,7	255
EY250x200	250x200	305	161	240	130	4,7	255



Тройник электросварной SDR 11



Артикул	dn1xdn2xdn1	Ø A1	L	L2	L3
ET20x20x20	20x20x20	30	110	45	67
ET25x20x25	25x20x25	35	115	46	69
ET 25x25x25	25x25x25	35	120	48	71
ET32x20x32	32x20x32	42	117	43	69
ET32x25x32	32x25x32	42	117	43	69
ET32x32x32	32x32x32	42	117	43	69
ET40x20x40	40x20x40	52	122	54	85
ET40x25x40	40x25x40	52	122	54	85
ET40x32x40	40x32x40	52	122	54	85
ET40x40x40	40x40x40	52	123	60	92
ET50x25x50	50x25x50	64	156	56	93
ET50x32x50	50x32x50	64	156	63	100
ET50x40x50	50x40x50	64	155	68	105
ET50x50x50	50x50x50	64	156	70	107
ET63x25x63	63x25x63	80	156	53	103
ET63x32x63	63x32x63	80	140	57	103
ET63x40x63	63x40x63	80	160	64	106
ET63x50x63	63x50x63	80	173	71	116
ET63x63x63	63x63x63	80	176	65	110
ET75x32x75	75x32x75	95	208	74	124
ET75x40x75	75x40x75	95	208	74	124
ET75x50x75	75x50x75	95	208	74	124
ET75x63x75	75x63x75	95	208	74	124
ET75x75x75	75x75x75	95	210	81	132
ET90x32x90	90x32x90	112	218	57	112
ET90x40x90	90x40x90	112	218	57	112
ET90x50x90	90x50x90	112	218	77	132
ET90x63x90	90x63x90	112	218	75	130
ET90x75x90	90x75x90	112	218	78	139
ET90x90x90	90x90x90	112	218	94	148

Артикул	dn1xdn2xdn1	Ø A1	L	L2	L3
ET110x32x110	110x32x110	138	262	69	143
ET110x40x110	110x40x110	138	262	69	143
ET110x50x110	110x50x110	138	262	81	156
ET110x63x110	110x63x110	138	261	74	146
ET110x75x110	110x75x110	138	261	74	146
ET110x90x110	110x90x110	138	260	95	168
ET110x110x110	110x110x110	138	260	92	160
ET160x50x160	160x50x160	195	345	90	192
ET160x63x160	160x63x160	195	295	92	205
ET160x90x160	160x90x160	195	295	90	202
ET160x110x160	160x110x160	195	345	110	215
ET160x160x160	160x160x160	195	345	120	227
ET200x63x200	200x63x200	245	385	96	225
ET200x90x200	200x90x200	245	320	68	218
ET200x110x200	200x110x200	245	385	105	237
ET200x160x200	200x160x200	245	385	110	237
ET200x200x200	200x200x200	245	385	120	251
ET250x160x250	250x160x250	302	465	108	287
ET250x200x250	250x200x250	302	465	121	292
ET250x250x250	250x250x250	302	470	135	312
ET315x200x315	315x200x315	374	575	120	328
ET315x250x315	315x250x315	374	575	135	342
ET315x315x315	315x315x315	374	575	163	370

Угол 90° (отвод 90°) электросварной SDR 11

Артикул	dn	Ø A	L
EL90.20	20	28	55
EL90.25	25	33	60
EL90.32	32	44	65
EL90.40	40	52	72
EL90.50	50	64	87
EL90.63	63	80	90
EL90.75	75	95	110
EL90.90	90	112	120
EL90.110	110	134	140
EL90.160	160	195	205
EL90.200	200	245	215
EL90.250	250	250	285
EL90.315	315	383	335

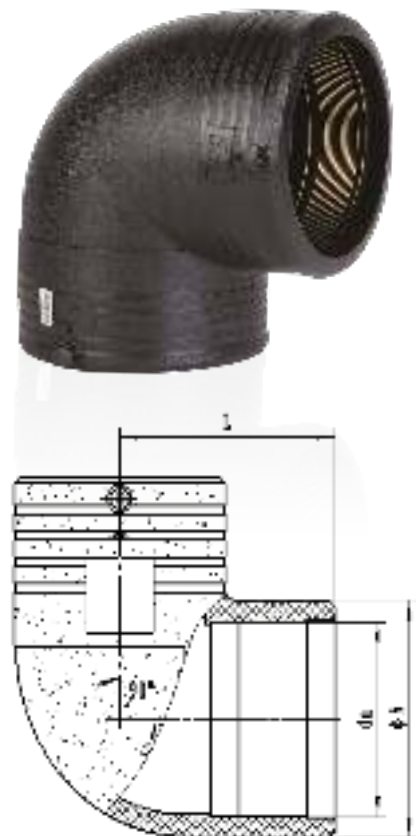



Угол 45°(отвод 45°) электросварной SDR 11

Артикул	dn	Ø A	L
EL45.50	50	70	155
EL45.63	63	80	165
EL45.90	90	112	200
EL45.110	110	134	223
EL45.160	160	195	290
EL45.200	200	250	380
EL45.225	225	290	390
EL45.250	250	305	425



Заглушка электросварная SDR 11

Артикул	dn	H	L
EM32	32	60	95
EM40	40	68	105
EM50	50	82	115
EM63	63	96	130

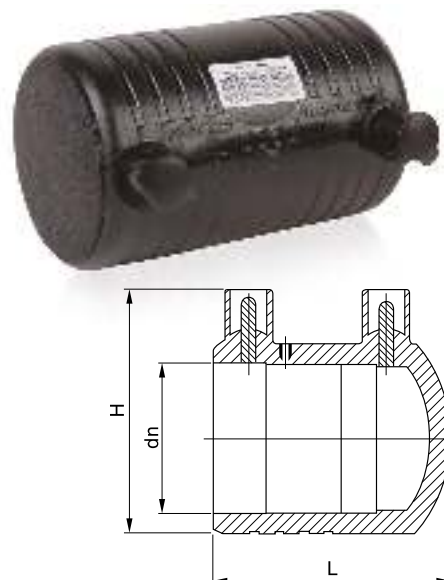

Ремонтная седельная накладка SDR 11

Артикул	dn1	A	L
EF90	90	180	50
EF110	110	180	55
EF125	125	180	60
EF160	160	180	55
EF200	200	245	80
EF250	250	245	80
EF315	315	315	110



Седельный патрубок для врезки под давлением электросварной SDR 11



Артикул	dn1xdn2	A	L	L1	L2
EJ63x32	63x32	118	125	80	48
EJ90x63	90x63	180	220	165	60
EJ110x40	110x40	180	220	165	55
EJ110x63	110x63	180	220	165	55
EJ125x63	125x63	150	220	165	55
EJ160x63	160x63	224	315	215	75
EJ160x90	160x90	224	315	215	75
EJ200x90	200x90	224	305	215	65
EJ250x90	250x90	224	295	215	60
EJ315x110	315x110	310	460	195	102

Электросварной универсальный отвод с регулируемым отклонением от 0° до 12° SDR 11



Артикул	dn	dn1	L1	L2
EA090	90	133	82	155
EA110	110	162	85	180
EA160	160	223	110	224
EA200	200	285	115	275



Седельный патрубок электросварной SDR 11

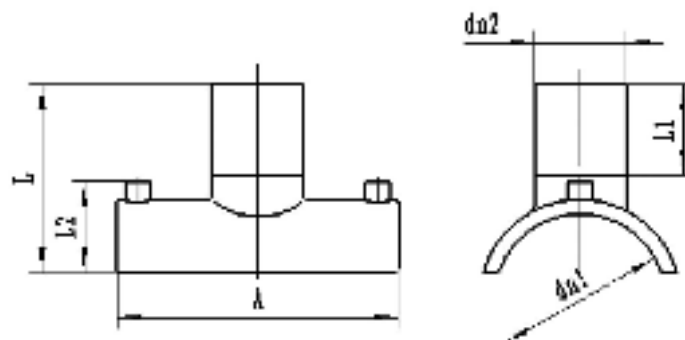

Артикул	dn1x dn2	A	L	L1	L2
EZ90x63	90x63	182	120	69	61
EZ110x63	110x63	180	120	70	58
EZ125x63	125x63	180	125	63	63
EZ160x63	160x63	182	120	65	55
EZ200x63	200x63	248	140	75	70
EZ200x90	200x90	248	160	100	70
EZ250x63	250x63	248	150	100	70
EZ250x90	250x90	248	155	100	62
EZ315x110	315x110	315	198	85	98
EZ315x160	315x160	315	190	82	98



Втулка под фланец удлиненная SDR 11, SDR17



Артикул	dn	Ø A	L	L1	SDR
MF40	40	81	82	11	11
MF50	50	88	84	13	11
MF63	63	104	96	15	11
MF75	75	120	99	16	11
MF90	90	138	110	17	11
MF110	110	158	111	20	11, 17, 17.6
MF125	125	211	156	26	11, 17, 17.6
MF160	160	212	147	26	11, 17, 17.6
MF180	180	212	153	27	11, 17, 17.6
MF200	200	212	172	27	11, 17, 17.6
MF225	225	268	195	35	11, 17, 17.6
MF250	250	320	192	32	11, 17, 17.6
MF280	280	320	218	33	11, 17, 17.6
MF315	315	371	174	39	11, 17, 17.6
MF355	355	430	190	44	11, 17, 17.6
MF400	400	484	192	43	11, 17, 17.6
MF450	450	530	225	45	11, 17, 17.6
MF500	500	585	235	45	11, 17, 17.6
MF560	560	685	295	62	11, 17, 17.6
MF630	630	683	240	70	11, 17, 17.6
MF710	710	587	280	60	11, 17, 17.6
MF800	800	900	340	92	11, 17, 17.6
MF900	900	1005	277	67	11, 17, 17.6
MF1000	1000	1105	310	110	11, 17, 17.6
MF1200	1200	1327	358	116	11, 17, 17.6



Переход (спигот) SDR 11, SDR17



Артикул	dn	L1	L2	L3	SDR
MY40x32	40x32	129	65	56	11
MY50x25	50x25	140	67	58	11
MY50x32	50x32	137	67	60	11
MY50x40	50x40	130	68	57	11
MY63x32	63x32	146	69	52	11
MY63x40	63x40	148	70	58	11
MY63x50	63x50	140	68	62	11
MY75x63	75x63	163	80	75	11
MY90x40	90x40	153	79	55	11
MY90x50	90x50	172	85	65	11
MY90x50	90x50	172	85	65	17, 17.6
MY90x63	90x63	172	85	70	11
MY90x63	90x63	172	85	70	17, 17.6
MY90x75	90x75	173	85	80	11
MY110x40	110x40	178	87	54	11
MY110x50	110x50	180	85	63	11
MY110x50	110x50	180	85	63	17, 17.6
MY110x63	110x63	176	85	65	11
MY110x63	110x63	185	87	83	17, 17.6
MY110x75	110x75	180	85	67	11
MY110x90	110x90	174	87	79	11
MY110x90	110x90	185	86	89	17, 17.6
MY125x110	125x110	204	108	85	11
MY140x110	140x110	230	98	87	11
MY160x63	160x63	216	100	65	11
MY160x63	160x63	200	101	68	17, 17.6
MY160x75	160x75	205	102	73	11
MY160x90	160x90	215	100	79	11
MY160x90	160x90	195	101	79	17, 17.6
MY160x110	160x110	215	100	85	11
MY160x110	160x110	195	101	82	17, 17.6
MY160x125	160x125	206	98	92	11
MY160x140	160x140	210	101	94	11

ЛИТЫЕ ФИТИНГИ ТИПА СПИГОТ

Артикул	dn	L1	L2	L3	SDR
MY160x140	160x140	210	101	94	17, 17.6
MY180x110	180x110	216	103	98	11
MY180x125	180x125	223	104	100	11
MY180x160	180x160	230	105	105	11
MY200x63	200x63	262	122	97	11
MY200x63	200x63	255	124	84	17, 17.6
MY200x90	200x90	262	120	105	11
MY200x90	200x90	245	117	87	17, 17.6
MY200x110	200x110	263	123	92	11
MY200x110	200x110	240	119	90	17, 17.6
MY200x160	200x160	258	125	110	11
MY200x160	200x160	240	119	114	17, 17.6
MY200x180	200x180	265	110	118	11
MY225x90	225x90	268	114	109	17, 17.6
MY225x110	225x110	269	111	110	11
MY225x110	225x110	269	111	110	17, 17.6
MY225x140	225x140	273	115	112	11
MY225x140	225x140	273	115	112	17, 17.6
MY225x160	225x160	275	124	119	11
MY225x160	225x160	275	124	119	17, 17.6
MY225x200	225x200	278	130	115	11
MY225x200	225x200	278	130	115	17, 17.6
MY250x90	250x90	280	140	94	11
MY250x110	250x110	280	143	98	11
MY250x110	250x110	280	134	113	17, 17.6
MY250x160	250x160	290	145	98	11
MY250x160	250x160	280	134	113	17, 17.6
MY250x180	250x180	280	136	115	11
MY250x200	250x200	288	150	114	11
MY250x200	250x200	280	134	125	17, 17.6
MY250x225	250x225	285	143	130	11
MY280x110	280x110	287	145	133	11
MY280x110	280x110	287	145	133	17, 17.6
MY280x140	280x140	290	140	135	11
MY280x160	280x160	292	139	130	11
MY280x200	280x200	293	141	129	11
MY280x200	280x200	293	141	129	17, 17.6
MY280x225	280x225	295	143	131	11
MY280x250	280x250	295	145	136	11
MY315x140	315x140	313	150	135	11
MY315x160	315x160	320	156	140	11
MY315x160	315x160	320	156	140	17, 17.6
MY315x180	315x180	316	152	127	11
MY315x200	315x200	310	150	118	11
MY315x200	315x200	325	156	130	17, 17.6
MY315x250	315x250	306	150	125	11
MY315x250	315x250	320	156	140	17, 17.6
MY315x280	315x280	265	130	132	11
MY355x160	355x160	352	160	141	17, 17.6
MY355x200	355x200	358	163	146	17, 17.6
MY355x225	355x225	360	159	143	11



Артикул	dn	L1	L2	L3	SDR
MY355x225	355x225	360	159	143	17, 17.6
MY355x250	355x250	359	148	144	17, 17.6
MY355x280	355x280	364	165	158	11
MY355x280	355x280	364	165	158	17, 17.6
MY355x315	355x315	365	172	162	11
MY355x315	355x315	365	172	162	17, 17.6
MY400x200	400x200	360	183	125	11
MY400x200	400x200	360	183	125	17, 17.6
MY400x250	400x250	380	183	180	11
MY400x250	400x250	380	183	180	17, 17.6
MY400x315	400x315	390	182	165	11
MY400x315	400x315	390	182	165	17, 17.6
MY400x355	400x355	380	179	164	11
MY400x355	400x355	380	179	164	17, 17.6
MY450x400	450x400	365	160	170	11
MY450x400	450x400	365	160	170	17, 17.6
MY500x200	500x200	340	160	160	11
MY500x200	500x200	340	160	160	17, 17.6
MY500x250	500x250	380	100	155	17, 17.6
MY500x355	500x355	420	40	130	11
MY500x355	500x355	420	40	130	17, 17.6
MY500x400	500x400	220	40	140	11
MY500x400	500x400	220	40	140	17, 17.6
MY500x450	500x450	340	160	160	11
MY500x450	500x450	340	160	160	17, 17.6
MY560x500	560x500	200	140	40	11
MY560x500	560x500	200	140	40	17, 17.6
MY630x315	630x315	470	155	40	17, 17.6
MY630x355	630x355	485	160	40	17, 17.6
MY630x400	630x400	490	180	40	17, 17.6
MY630x500	630x500	500	200	40	11
MY630x500	630x500	500	200	40	17, 17.6
MY630x560	630x560	280	200	40	11
MY630x560	630x560	280	200	40	17, 17.6
MY710x630	710x630	210	40	120	11
MY710x630	710x630	210	40	120	17, 17.6
MY800x630	800x630	470	60	120	11
MY800x630	800x630	470	60	120	17, 17.6
MY800x710	800x710	260	60	140	11
MY800x710	800x710	260	60	140	17, 17.6
MY900x800	900x800	445	205	200	11
MY900x800	900x800	445	205	200	17, 17.6
MY1000x900	1000x900	450	205	200	11
MY1000x900	1000x900	450	205	200	17, 17.6
MY1200x1000	1200x1000	430	180	175	11
MY1200x1000	1200x1000	430	180	175	17, 17.6

Тройник (спигот) SDR 11, SDR17



Артикул	dn1x dn_2 x dn_1	L1	L2	L3	SDR
MT50x50x50	50x50x50	182	57	55	11
MT63x32x63	63x32x63	200	65	51	11
MT63x40x63	63x40x63	200	67	54	11
MT63x50x63	63x50x63	200	65	55	11
MT63x63x63	63x63x63	211	66	66	11
MT90x32x90	90x32x90	226	82	52	11
MT90x40x90	90x40x90	228	83	52	11
MT90x50x90	90x50x90	283	87	60	11
MT90x63x90	90x63x90	285	83	68	11
MT90x75x90	90x75x90	283	83	70	11
MT90x90x90	90x90x90	283	87	87	11
MT110x32x110	110x32x110	237	78	52	11
MT110x40x110	110x40x110	238	81	52	11
MT110x40x110	110x40x110	228	82	50	17, 17.6
MT110x50x110	110x50x110	280	87	61	11
MT110x63x110	110x63x110	280	87	72	11
MT110x63x110	110x63x110	300	82	75	17, 17.6
MT110x90x110	110x90x110	307	87	82	11
MT110x90x110	110x90x110	300	85	80	17, 17.6
MT110x110x110	110x110x110	320	87	87	11
MT110x110x110	110x110x110	300	85	80	17, 17.6



Артикул	dn1xdn2xdn1	L1	L2	L3	SDR
MT125x63x125	125x63x125	327	118	87	11
MT125x125x125	125x125x125	327	118	118	11
MT125x125x125	125x125x125	305	116	111	17, 17.6
MT140x140x140	140x140x140	373	92	92	11
MT160x50x160	160x50x160	440	123	85	11
MT160x63x160	160x63x160	360	109	94	11
MT160x63x160	160x63x160	400	100	85	17, 17.6
MT160x90x160	160x90x160	362	109	95	11
MT160x90x160	160x90x160	400	100	75	17, 17.6
MT160x110x160	160x110x160	360	108	97	11
MT160x110x160	160x110x160	400	100	95	17, 17.6
MT160x160x160	160x160x160	424	117	117	11
MT160x160x160	160x160x160	400	100	100	17, 17.6
MT180x180x180	180x180x180	457	105	105	11
MT200x63x200	200x63x200	408	117	71	11
MT200x63x200	200x63x200	380	120	98	17, 17.6
MT200x90x200	200x90x200	407	117	90	11
MT200x90x200	200x90x200	380	120	98	17, 17.6
MT200x110x200	200x110x200	410	118	90	11
MT200x110x200	200x110x200	480	120	85	17, 17.6
MT200x160x200	200x160x200	482	128	103	11
MT200x160x200	200x160x200	480	120	100	17, 17.6
MT200x200x200	200x200x200	482	125	117	11
MT200x200x200	200x200x200	480	120	120	17, 17.6
MT225x63x225	225x63x225	360	100	65	11
MT225x75x225	225x75x225	360	100	67	11
MT225x75x225	225x75x225	360	100	67	17, 17.6
MT225x90x225	225x90x225	360	100	72	11
MT225x90x225	225x90x225	360	100	72	17, 17.6
MT225x110x225	225x110x225	360	100	80	11
MT225x110x225	225x110x225	360	100	80	17, 17.6
MT225x160x225	225x160x225	475	100	100	11
MT225x225x225	225x225x225	475	100	100	11
MT250x63x250	250x63x250	458	129	70	11
MT250x63x250	250x63x250	460	129	70	17, 17.6
MT250x90x250	250x90x250	460	129	91	11
MT250x90x250	250x90x250	460	129	90	17, 17.6
MT250x110x250	250x110x250	457	129	90	11
MT250x110x250	250x110x250	460	129	90	17, 17.6
MT250x160x250	250x160x250	501	135	108	11
MT250x160x250	250x160x250	505	135	110	17, 17.6
MT250x200x250	250x200x250	505	140	115	11
MT250x200x250	250x200x250	505	135	115	17, 17.6
MT250x250x250	250x250x250	572	134	134	11
MT250x250x250	250x250x250	575	140	135	17, 17.6
MT315x90x315	315x90x315	600	150	87	11
MT315x110x315	315x110x315	598	150	92	11

ЛИТЫЕ ФИТИНГИ ТИПА СПИГОТ

Артикул	dn1xdn2xdn1	L1	L2	L3	SDR
MT315x110x315	315x110x315	600	145	90	17, 17.6
MT315x160x315	315x160x315	592	150	111	11
MT315x160x315	315x160x315	600	150	110	17, 17.6
MT315x200x315	315x200x315	592	150	128	11
MT315x200x315	315x200x315	600	150	130	17, 17.6
MT315x225x315	315x225x315	658	150	133	11
MT315x250x315	315x250x315	727	150	136	11
MT315x250x315	315x250x315	675	150	140	17, 17.6
MT315x315x315	315x315x315	592	150	150	11
MT315x315x315	315x315x315	680	150	150	17, 17.6
MT355x225x355	355x225x355	705	157	148	17, 17.6
MT355x250x355	355x250x355	725	168	142	11
MT355x315x355	355x315x355	730	170	164	11
MT355x315x355	355x315x355	730	170	164	17, 17.6
MT355x355x355	355x355x355	726	165	164	11
MT355x355x355	355x355x355	650	154	141	17, 17.6
MT400x225x400	400x225x400	740	174	162	17, 17.6
MT400x315x400	400x315x400	750	180	159	11
MT400x315x400	400x315x400	750	180	159	17, 17.6
MT400x355x400	400x355x400	777	179	164	11
MT400x355x400	400x355x400	777	179	164	17, 17.6
MT400x400x400	400x400x400	777	179	179	11
MT400x400x400	400x400x400	779	179	179	17, 17.6
MT450x225x450	450x225x450	775	174	163	17, 17.6
MT450x315x450	450x315x450	778	176	165	17, 17.6
MT450x355x450	450x355x450	779	130	130	17, 17.6
MT450x450x450	450x450x450	780	120	120	11
MT450x450x450	450x450x450	780	120	120	17, 17.6
MT500x355x500	500x355x500	860	145	135	17, 17.6
MT500x400x500	500x400x500	910	157	170	17, 17.6
MT500x450x500	500x450x500	912	157	165	17, 17.6
MT500x500x500	500x500x500	912	157	157	17, 17.6
MT560x355x560	560x355x560	936	168	163	17, 17.6
MT630x160x630	630x160x630	952	173	168	17, 17.6
MT630x250x630	630x250x630	957	179	172	17, 17.6
MT630x315x630	630x315x630	963	184	175	17, 17.6
MT630x400x630	630x400x630	971	187	179	17, 17.6
MT630x500x630	630x500x630	980	169	157	17, 17.6
MT630x560x630	630x560x630	986	190	178	17, 17.6
MT630x630x630	630x630x630	990	196	181	11
MT630x630x630	630x630x630	990	196	181	17, 17.6



Отвод 90° (спигот) SDR 11, SDR17



Артикул	dn	L	L1	SDR
ML90.20	20	65	45	11
ML90.25	25	68	45	11
ML90.32	32	63	45	11
ML90.40	40	74	49	11
ML90.50	50	90	63	11
ML90.63	63	98	64	11
ML90.75	75	101	78	11
ML90.90	90	125	83	11
ML90.110	110	155	90	11
ML90.110	110	90	82	17, 17.6
ML90.125	125	159	87	11
ML90.140	140	190	92	11
ML90.160	160	212	107	11
ML90.160	160	107	100	17, 17.6
ML90.180	180	223	105	11
ML90.200	200	240	120	11
ML90.200	200	120	115	17, 17.6
ML90.225	225	253	120	11
ML90.250	250	267	129	11
ML90.250	250	129	129	17, 17.6
ML90.280	280	137	131	11
ML90.280	280	205	170	17, 17.6
ML90.315	315	345	160	11
ML90.315	315	164	160	17, 17.6
ML90.355	355	360	164	11
ML90.355	355	164	164	17, 17.6
ML90.400	400	374	179	11
ML90.400	400	179	179	17, 17.6
ML90.450	450	365	195	17, 17.6
ML90.500	500	212	169	17, 17.6
ML90.630	630	294	178	11
ML90.630	630	294	178	17, 17.6

Отвод 45° (спигот) SDR 11, SDR17



Артикул	dn	L	SDR
ML45.50	50	62	11
ML45.63	63	68	11
ML45.75	75	73	11
ML45.90	90	87	11
ML45.110	110	111	11
ML45.110	110	111	17, 17.6
ML45.125	125	116	11
ML45.160	160	121	11
ML45.160	160	121	17, 17.6
ML45.180	180	133	11
ML45.200	200	140	11
ML45.200	200	140	17, 17.6
ML45.225	225	143	11
ML45.250	250	138	11
ML45.250	250	138	17, 17.6
ML45.280	280	147	11
ML45.315	315	152	11
ML45.315	315	158	17, 17.6
ML45.355	355	164	11
ML45.355	355	164	17, 17.6
ML45.400	400	175	11
ML45.400	400	175	17, 17.6
ML45.450	450	169	17, 17.6
ML45.630	630	164	17, 17.6



Заглушка (спигот) SDR 11, SDR17



Артикул	dn	L	L ₁	SDR
MM20	20	41	55	11
MM25	25	42	57	11
MM32	32	44	57	11
MM40	40	49	67	11
MM50	50	55	71	11
MM63	63	63	88	11
MM75	75	70	135	11
MM90	90	79	116	11
MM110	110	85	138	11
MM110	110	85	100	17, 17.6
MM125	125	107	140	11
MM140	140	103	138	11
MM160	160	105	142	11
MM160	160	100	125	17, 17.6
MM180	180	108	130	11
MM200	200	114	163	11
MM200	200	112	142	17, 17.6
MM225	225	116	147	11
MM225	225	120	150	17, 17.6
MM250	250	148	182	11
MM250	250	145	170	17, 17.6
MM280	280	149	174	11
MM315	315	154	185	11

Артикул	dn	L	L ₁	SDR
MM315	315	155	185	17, 17.6
MM355	355	164	185	11
MM355	355	164	185	17, 17.6
MM400	400	179	215	11
MM400	400	179	200	17, 17.6
MM450	450	195	315	11
MM450	450	169	225	17, 17.6
MM500	500	212	315	11
MM500	500	169	315	17, 17.6
MM560	560	235	315	11
MM560	560	195	270	17, 17.6
MM630	630	255	330	11
MM630	630	220	350	17, 17.6
MM710	710	200	450	11
MM710	710	200	450	17, 17.6
MM800	800	200	450	11
MM800	800	200	450	17, 17.6
MM900	900	200	450	11
MM900	900	200	450	17, 17.6
MM1000	1000	200	450	11
MM1000	1000	200	450	17, 17.6
MM1200	1200	200	450	11
MM1200	1200	200	450	17, 17.6

Фланец стальной с ПОЛИМЕРНЫМ антикоррозийным покрытием



Артикул	DN (mm)	ПЭ (dn)	D (mm)	B (mm)	H (mm)	K (mm)	Lxn*	sc (mm)
MP040 PN16	32	40	140	51	16	100	18x4	M16
MP050 PN16	40	50	150	62	18	110	18x4	M16
MP063 PN16	50	63	165	78	18	125	18x4	M16
MP075 PN16	65	75	188	92	18	145	18x4	M16
MP090 PN16	80	90	204	108	20	160	18x8	M16
MP110 PN16	100	110	224	128	20	180	18x8	M16
MP125 PN16	100	125	224	135	20	180	18x8	M16
MP140 PN16	125	140	252	158	22	210	18x8	M16
MP160 PN16	150	160	285	178	22	240	22x8	M20
MP180 PN16	150	180	285	188	22	240	22x8	M20
MP200 PN16	200	200	340	235	24	295	22x12	M20
MP225 PN16	200	225	340	238	24	295	22x12	M20
MP250 PN16	250	250	395	288	32	355	26x12	M24
MP280 PN16	250	280	395	294	32	355	26x12	M24
MP315 PN16	300	315	445	338	34	410	26x12	M24
MP355 PN16	350	355	514	376	42	470	26x16	M24
MP400 PN16	400	400	571	430	46	525	30x16	M27
MP200 PN10	200	200	340	235	24	295	22x8	M20
MP225 PN10	200	225	340	238	24	295	22x8	M20
MP250 PN10	250	250	395	288	26	355	22x12	M20
MP280 PN10	250	280	395	294	26	355	22x12	M20
MP315 PN10	300	315	445	338	26	410	22x12	M20
MP355 PN10	350	355	514	376	28	470	22x16	M20
MP400 PN10	400	400	571	430	30	525	26x16	M24
MP450 PN10	500	450	678	517	32	620	26x20	M24
MP500 PN10	500	500	688	533	32	620	26x20	M24
MP560 PN10	600	560	799	618	42	725	30x20	M27
MP630 PN10	600	630	799	645	42	725	30x20	M27



Переход ПЭ/сталь

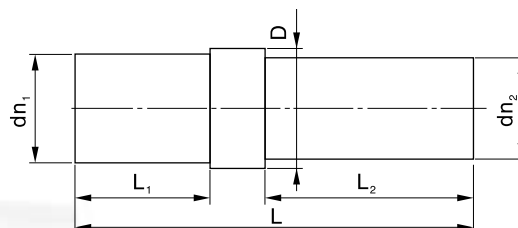

Артикул	dn2xdn1	D	L	L1	L2
SW20/22	20x22	45	395	105	230
SW25/27	25x27	45	395	105	230
SW32/34	32x34	50	410	125	230
SW40/34	40x34	60	410	125	230
SW40/42	40x42	60	410	125	230
SW40/45	40x45	60	410	125	230
SW50/34	50x34	70	410	125	230
SW50/42	50x42	70	410	125	230
SW50/45	50x45	70	410	125	230
SW50/48	50x48	70	410	125	230
SW63/42	63x42	83	410	125	230
SW63/48	63x48	83	410	125	230
SW63/57	63x57	83	410	125	230
SW63/60	63x60	83	410	125	230
SW90/76	90x76	109	410	105	210
SW90/89	90x89	109	410	105	300
SW110/89	110x89	128	410	170	300
SW110/108	110x108	128	410	170	300
SW160/159	160x159	168	620	190	330
SW200/203	200x203	219	700	210	380
SW200/219	200x219	219	700	210	380
SW250/219	250x219	273	760	220	420
SW250/245	250x245	273	760	220	420
SW250/273	250x273	273	760	220	420
SW315/299	315x299	325	830	190	420
SW315/325	315x325	325	830	190	420
SW355/325	355x325	377	870	230	420
SW355/377	355x377	377	870	230	420
SW400/402	400x402	426	870	230	420

Цокольный ввод



Артикул	dn	L1	L2	L3
SQ020/22	20	120	350	800(1200)
SQ025/27	25	120	350	800(1200)
SQ032/34	32	125	400	800(1200)
SQ040/42	40	130	400	800(1200)
SQ050/48	50	130	440	800(1200)
SQ063/63	63	130	500	800(1200)

Переход на резьбу ПЭ/сталь с наружной резьбой



Артикул	dnxR	D	L	L1	L2
SP025/3/4	25x3/4	42	185	23	100
SP032/1	32xR1	50	205	23	120
SP040/1	40xR1	60	205	23	120
SP040/11/4	40xR11/4	60	205	23	120
SP050/1	50xR1	70	205	23	120
SP050/11/4	50xR11/4	70	205	23	120
SP050/11/2	50xR11/2	70	205	23	120
SP050/2	50xR2	70	210	23	120
SP063/11/4	63xR11/4	82	220	23	120
SP063/11/2	63xR11/2	82	220	23	140
SP063/2	63xR2	84	220	23	140



ROFITT

полиэтиленовые фитинги
и шаровые краны

www.rofitt.ru